

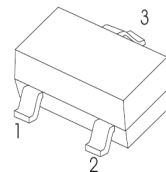

SOT-23 Plastic-Encapsulate Transistors

2SC5344 TRANSISTOR (NPN)

SOT-23



- 1. BASE
- 2. EMITTER
- 3. COLLECTOR

FEATURES

- Audio power amplifier application
- High h_{FE} : $h_{FE}=100\sim320$
- Complementary to 2SA1981

MAXIMUM RATINGS ($T_a=25^\circ\text{C}$ unless otherwise noted)

Symbol	Parameter	Value	Unit
V_{CBO}	Collector-Base Voltage	35	V
V_{CEO}	Collector-Emitter Voltage	30	V
V_{EBO}	Emitter-Base Voltage	5	V
I_C	Collector Current -Continuous	800	mA
P_C	Collector Power Dissipation	200	mW
T_j	Junction Temperature	150	$^\circ\text{C}$
T_{stg}	Storage Temperature	-55-150	$^\circ\text{C}$

ELECTRICAL CHARACTERISTICS ($T_a=25^\circ\text{C}$ unless otherwise specified)

Parameter	Symbol	Test conditions	Min	Typ	Max	Unit
Collector-base breakdown voltage	$V_{(BR)CBO}$	$I_C = 0.1\text{mA}, I_B=0$	35			V
Collector-emitter breakdown voltage	$V_{(BR)CEO}$	$I_C = 10\text{mA}, I_B=0$	30			V
Emitter-base breakdown voltage	$V_{(BR)EBO}$	$I_E = 0.01\text{mA}, I_C=0$	5			V
Collector cut-off current	I_{CBO}	$V_{CB}=35\text{V}, I_E=0$			0.1	μA
Emitter cut-off current	I_{EBO}	$V_{EB}= 5\text{V}, I_C=0$			0.1	μA
DC current gain	h_{FE}	$V_{CE}=1\text{V}, I_C= 100\text{mA}$	100		320	
Collector-emitter saturation voltage	$V_{CE(sat)}$	$I_C= 500\text{mA}, I_B=50\text{mA}$			0.5	V
Transition frequency	f_T	$V_{CE}=5\text{V}, I_C=10\text{mA}$		120		MHz
Collector Output Capacitance	C_{ob}	$V_{CB}=10\text{V}, I_E= 0, f=1\text{MHz}$		13		pF

CLASSIFICATION OF $h_{FE(1)}$

Rank	O	Y
Range	100-200	160-320
Marking	FAO	FAY

Typical Characteristics

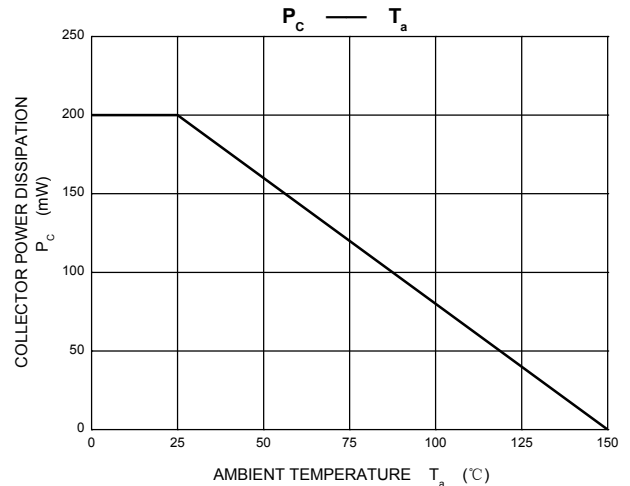
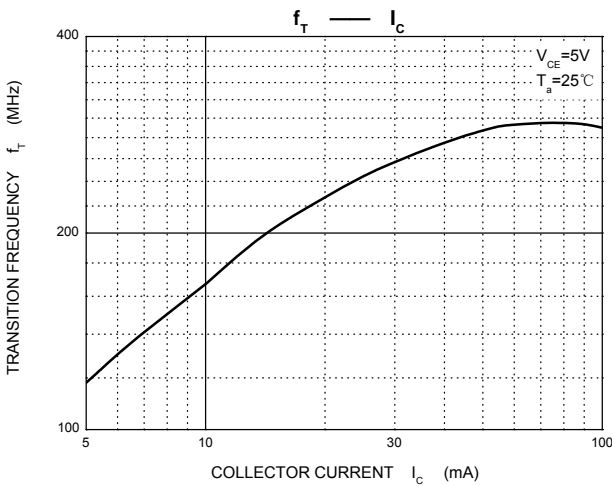
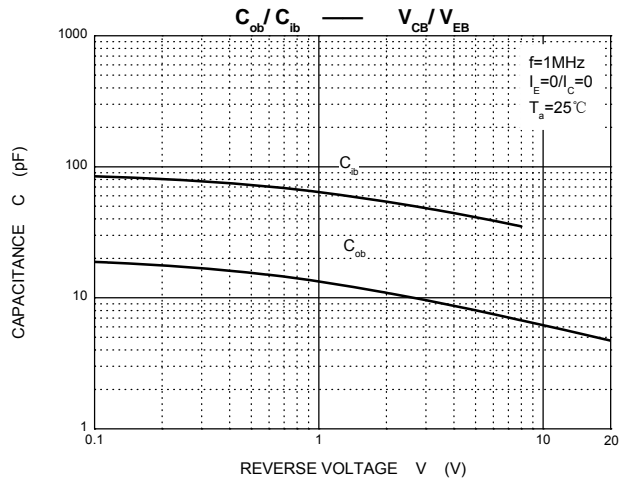
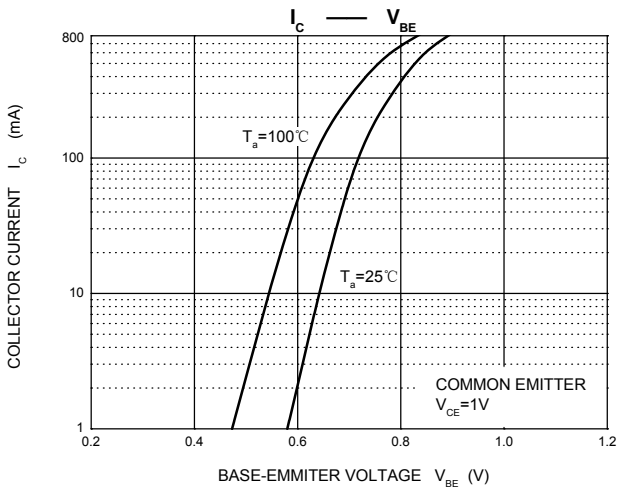
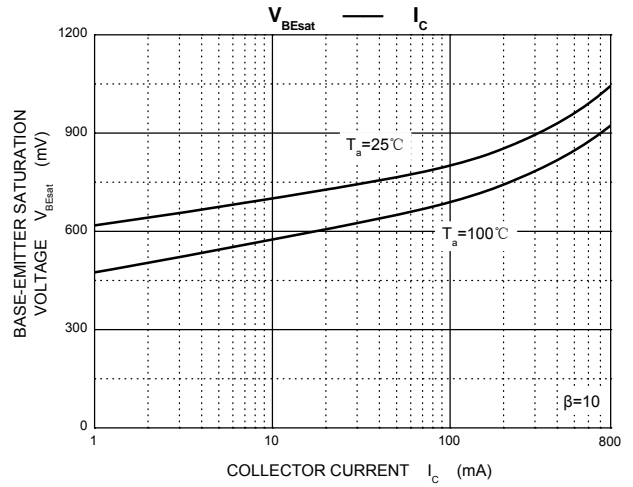
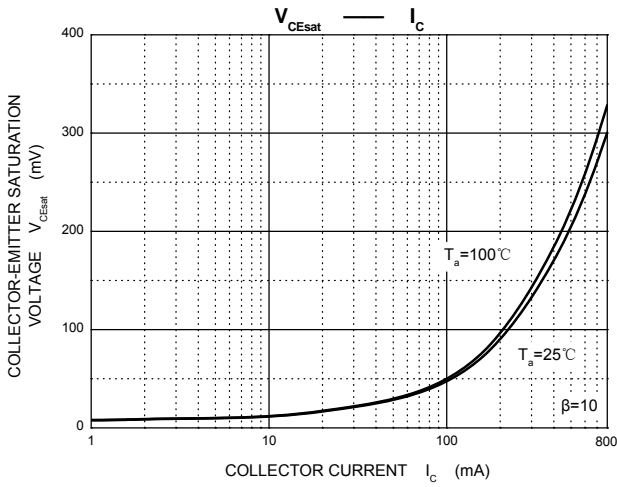
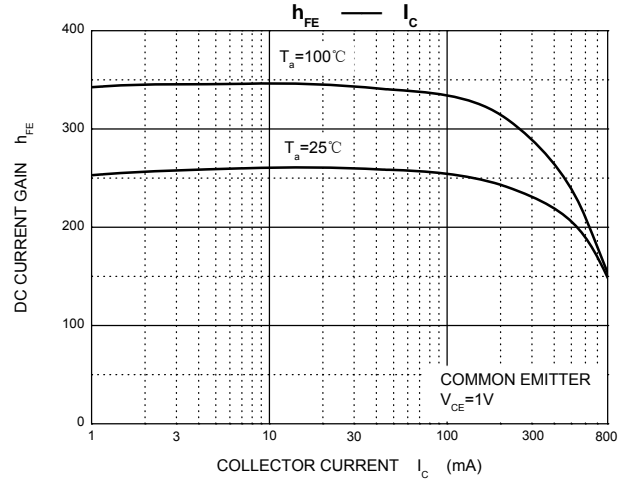
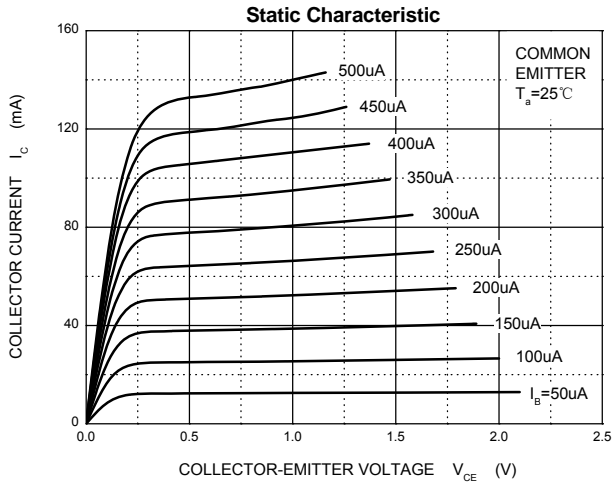

SOT-23 Package Outline Dimensions

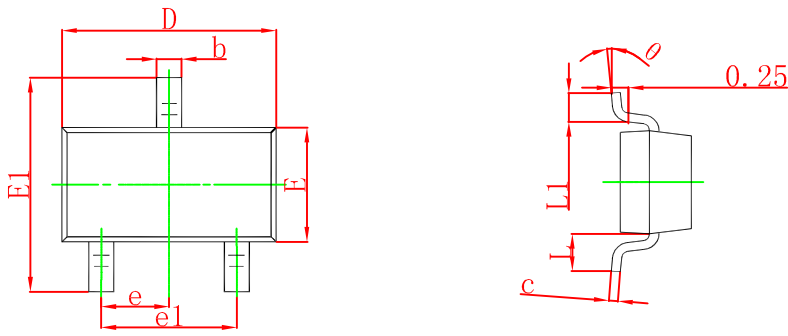

Symbol	Dimensions In Millimeters		Dimensions In Inches	
	Min	Max	Min	Max
A	0.900	1.150	0.035	0.045
A1	0.000	0.100	0.000	0.004
A2	0.900	1.050	0.035	0.041
b	0.300	0.500	0.012	0.020
c	0.080	0.150	0.003	0.006
D	2.800	3.000	0.110	0.118
E	1.200	1.400	0.047	0.055
E1	2.250	2.550	0.089	0.100
e	0.950 TYP		0.037 TYP	
e1	1.800	2.000	0.071	0.079
L	0.550 REF		0.022 REF	
L1	0.300	0.500	0.012	0.020
θ	0°	8°	0°	8°

SOT-23 Suggested Pad Layout



- Note:
1. Controlling dimension: in millimeters.
 2. General tolerance: ± 0.05 mm.
 3. The pad layout is for reference purposes only.

NOTICE

JCET reserve the right to make modifications, enhancements, improvements, corrections or other changes without further notice to any product herein. JCET does not assume any liability arising out of the application or use of any product described herein.

SOT-23 Tape and Reel

SOT-23 Embossed Carrier Tape



Packaging Description:

SOT-23 parts are shipped in tape. The carrier tape is made from a dissipative (carbon filled) polycarbonate resin. The cover tape is a multilayer film (Heat Activated Adhesive in nature) primarily composed of polyester film, adhesive layer, sealant, and anti-static sprayed agent. These reeled parts in standard option are shipped with 3,000 units per 7" or 17.8cm diameter reel. The reels are clear in color and is made of polystyrene plastic (anti-static coated).

Dimensions are in millimeter

Pkg type	A	B	C	d	E	F	P0	P	P1	W
SOT-23	3.15	2.77	1.22	Ø1.50	1.75	3.50	4.00	4.00	2.00	8.00

SOT-23 Tape Leader and Trailer



SOT-23 Reel

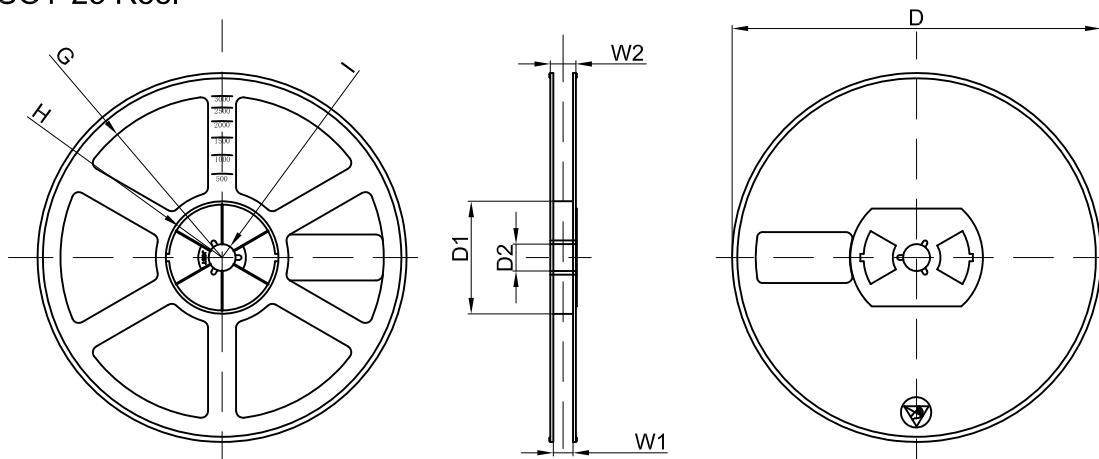

Dimensions are in millimeter

Reel Option	D	D1	D2	G	H	I	W1	W2
7"Dia	Ø178.00	54.40	13.00	R78.00	R25.60	R6.50	9.50	12.30

REEL	Reel Size	Box	Box Size(mm)	Carton	Carton Size(mm)	G.W.(kg)
3000 pcs	7 inch	45,000 pcs	203×203×195	180,000 pcs	438×438×220	